

Features

- Miniature Size
2.5 mm x 2.0 mm x 0.8 mm
- Insertion Loss:
 - Band3 Tx 2.0 dB Typ.
 - Band3 Rx 2.3 dB Typ.
 - Band1 Tx 1.8 dB Typ.
 - Band1 Rx 1.8 dB Typ.
- Tx-RX Isolation:
 - Band3 Tx Pass Band 57 dB Typ.
 - Band3 Rx Pass Band 61 dB Typ.
 - Band1 Tx Pass Band 60 dB Typ.
 - Band1 Rx Pass Band 63 dB Typ.
- Tx Input Power
 - Band1 TX Power: 30dBm
 - Band3 TX Power: 30dBm
- ESD protection ability: Class 1C
- Moisture Sensitivity: MSL3
- Storage Temperature: -45°C~85°C



6 Pin 2.5 x 2.0 x 0.75 mm Package

Functional Block Diagram (Top Thru View)

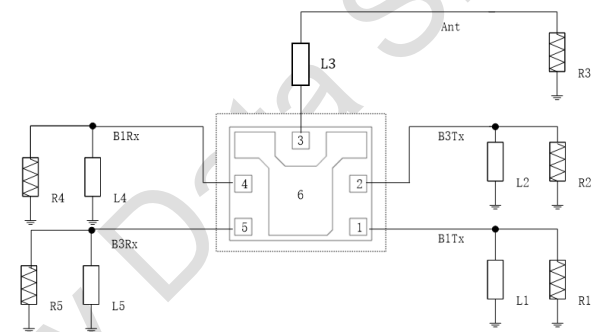

Environmental

- Full implement with RoHS compliant
- Lead Free (Pb free)



Reference Des.	Value	Description
R1	50ohm	
R2	50ohm	
R3	50ohm	
R4	50ohm	
R5	50ohm	
L1	7.5 nH	Ideal Inductor
L2	7.5 nH	Ideal Inductor
L3	0.8 nH	Ideal Inductor
L4	8.1 nH	Ideal Inductor
L5	8.1 nH	Ideal Inductor

Pin Connection

No.	Function
1	Band1 Tx
2	Band3 Tx
3	Ant
4	Band1 Rx
5	Band3 Rx
6	Ground

Electrical Specification

Band3 Transmit Port to Antenna Port

Parameter (Operation Temperature: -20~85°C)	Min	Typ*	Max	Unit
Insertion Loss (1710~1785MHz)	/	2.0	2.9	dB
Ripple (1710~1785MHz)	/	0.8	1.5	dB
VSWR (1710~1785MHz, ANT Port)	/	1.4	2.0	/
VSWR (1710~1785MHz, TX Port)	/	1.4	2.0	/
Absolute Attenuation (0~8000MHz)				
(0~1000 MHz)	43	50	/	dB
(1000~1560 MHz)	38	44	/	dB
(1565~1606 MHz)	41	46	/	dB
(1805~1880 MHz)	50	58	/	dB
(2010~2025 MHz)	42	49	/	dB
(2110~2170 MHz)	46	51	/	dB
(2300~2400 MHz)	45	50	/	dB
(2400~2483 MHz)	49	54	/	dB
(2620~2690 MHz)	52	57	/	dB
(2700~3400 MHz)	44	51	/	dB
(3420~3570 MHz),2f ₀	46	51	/	dB
(3600~5100 MHz)	43	50	/	dB
(5130~5355 MHz),3f ₀	54	59	/	dB
(5400~8000 MHz)	21	28	/	dB

Band3 Antenna Port to Receive Port

Parameter (Operation Temperature: -20~85°C)	Min	Typ*	Max	Unit
Insertion Loss (1805~1880MHz)	/	2.3	3.3	dB
Ripple (1805~1880MHz)	/	1.0	1.8	dB
VSWR (1805~1880MHz, ANT Port)	/	1.5	2.0	/
VSWR (1805~1880MHz, RX Port)	/	1.3	2.0	/
Absolute Attenuation (0~8000MHz)				
(0~1000 MHz)	48	54	/	dB
(1000~1680 MHz)	40	46	/	dB
(1710~1785 MHz)	51	56	/	dB
(1920~1980 MHz)	56	63	/	dB
(2300~2400 MHz)	46	52	/	dB
(2400~2500 MHz)	52	58	/	dB
(2500~2570 MHz)	58	65	/	dB
(3300~3600 MHz)	43	50	/	dB
(3610~3760 MHz),2f ₀	44	49	/	dB
(3800~5400 MHz)	42	49	/	dB
(5415~5640 MHz),3f ₀	49	54	/	dB
(5700~8000 MHz)	20	27	/	dB

Band1 Transmit Port to Antenna Port

Parameter (Operation Temperature: -20~85°C)	Min	Typ*	Max	Unit
Insertion Loss (1920~1980MHz)	/	1.8	2.7	dB
Ripple (1920~1980MHz)	/	0.6	1.4	dB
VSWR (1920~1980MHz, <i>ANT Port</i>)	/	1.3	2.0	/
VSWR (1920~1980MHz, <i>TX Port</i>)	/	1.3	2.0	/
Absolute Attenuation (0~8000MHz)				
(0~1000 MHz)	54	59	/	dB
(1000~1560 MHz)	44	49	/	dB
(1565~1606 MHz)	44	50	/	dB
(1805~1880 MHz)	47	51	/	dB
(2010~2025 MHz)	15	26	/	dB
(2110~2170 MHz)	55	61	/	dB
(2300~2400 MHz)	56	63	/	dB
(2400~2483 MHz)	57	62	/	dB
(2620~2690 MHz)	50	55	/	dB
(2700~3800 MHz)	40	47	/	dB
(3840~3960 MHz),2f0	42	47	/	dB
(4000~5400 MHz)	39	46	/	dB
(5760~5940 MHz),3f0	44	49	/	dB
(5950~8000 MHz)	30	36	/	dB

Band1 Antenna Port to Receive Port

Parameter (Operation Temperature: -20~85°C)	Min	Typ*	Max	Unit
Insertion Loss (2110~2170MHz)	/	1.8	2.7	dB
Ripple (2110~2170MHz)	/	0.8	1.6	dB
VSWR (2110~2170MHz, ANT Port)	/	1.2	2.0	/
VSWR (2110~2170MHz, RX Port)	/	1.3	2.0	/
Absolute Attenuation (0~8000MHz)				
(0~1000 MHz)	52	57	/	dB
(1000~1680 MHz)	43	48	/	dB
(1710~1785 MHz)	49	54	/	dB
(1920~1980 MHz)	55	62	/	dB
(2010~2025 MHz)	50	58	/	dB
(2300~2400 MHz)	46	51	/	dB
(2400~2500 MHz)	50	56	/	dB
(2500~2570 MHz)	52	57	/	dB
(2600~4200 MHz)	50	56	/	dB
(4220~4340 MHz),2f0	58	66	/	dB
(4400~6000 MHz)	38	43	/	dB
(6330~6510 MHz),3f0	35	41	/	dB
(6600~8000 MHz)	18	24	/	dB

Transmit Port to Receive Port

Parameter (Operation Temperature: -20~85°C)	Min	Typ*	Max	Unit
Band3 Isolation				
1710~1785MHz	50	57	/	dB
1805~1880MHz	53	61	/	dB
Band1 Isolation				
1920~1980MHz	55	60	/	dB
2110~2170MHz	58	63	/	dB
Band3 Tx to Band1 RX Cross-Isolation				
1710~1785MHz	51	55	/	dB
2110~2170MHz	50	53	/	dB
Band1 Tx to Band3 RX Cross-Isolation				
1920~1980MHz	57	62	/	dB
1805~1880MHz	48	51	/	dB

*Data is the integrated value of the linear s-parameter over indicated band

* Typical value at 25±3 °C

Typical Performance at Tc=25°C

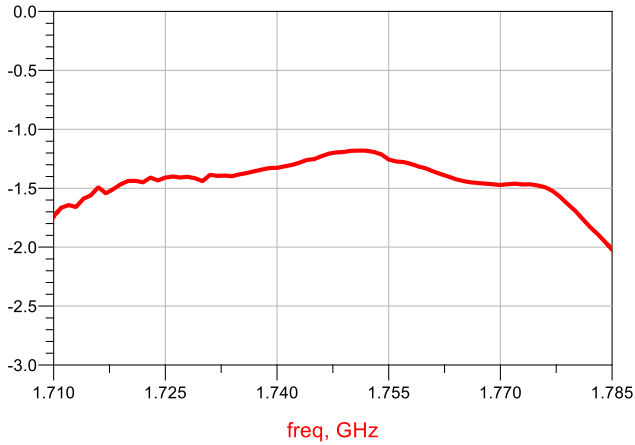

Figure1. Band3 TX-ANT Passband

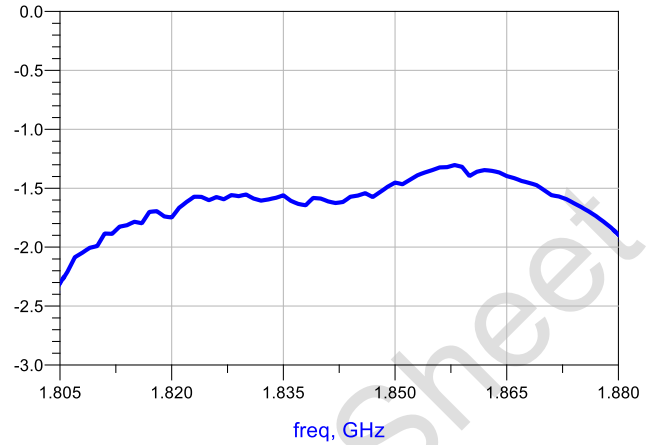

Figure2. Band3 ANT-RX Passband

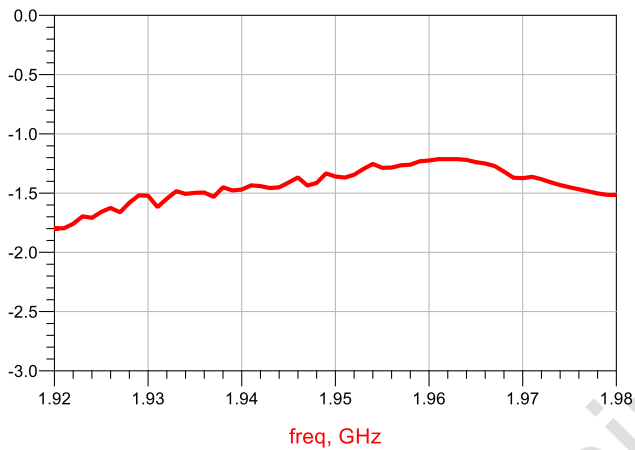

Figure3. Band1 TX-ANT Attenuation

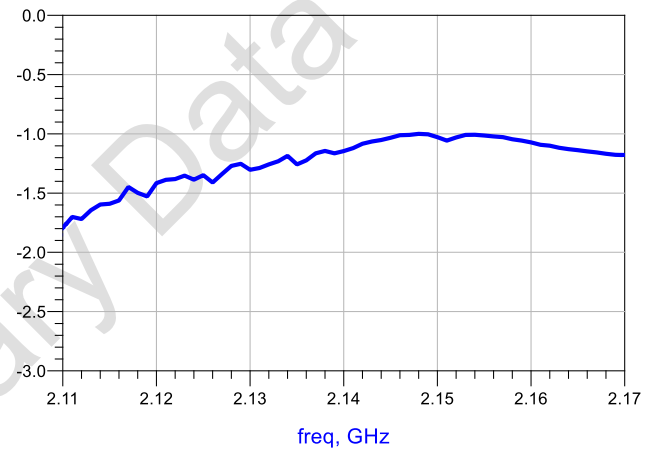

Figure4. Band1 ANT-RX Attenuation

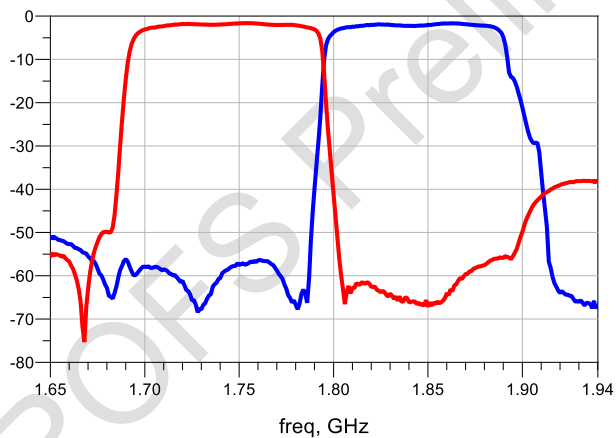

Figure5. Bnad3 TX/RX Attenuation

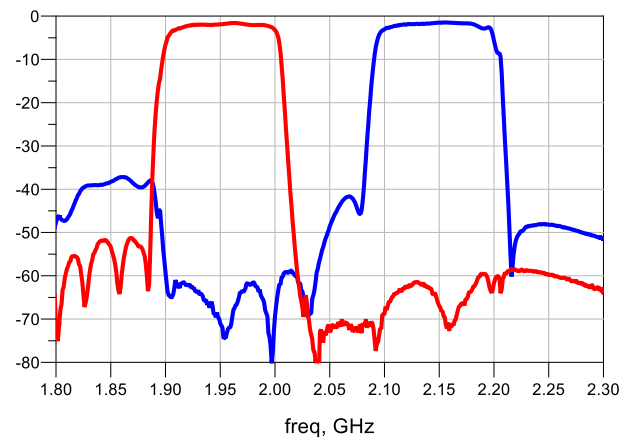

Figure6. Band1 TX/RX Attenuation

Typical Performance at Tc=25°C

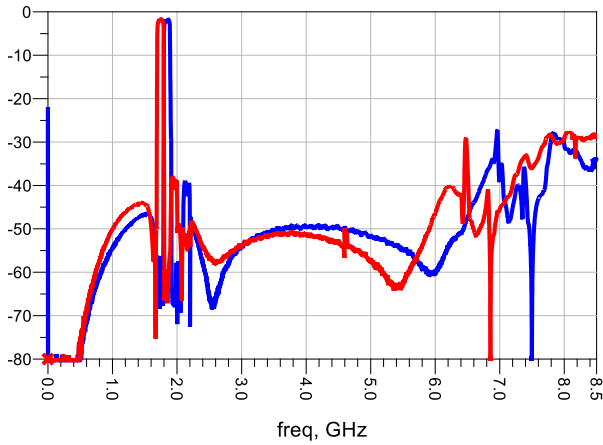

Figure7. Bnad3 TX/RX Wideband

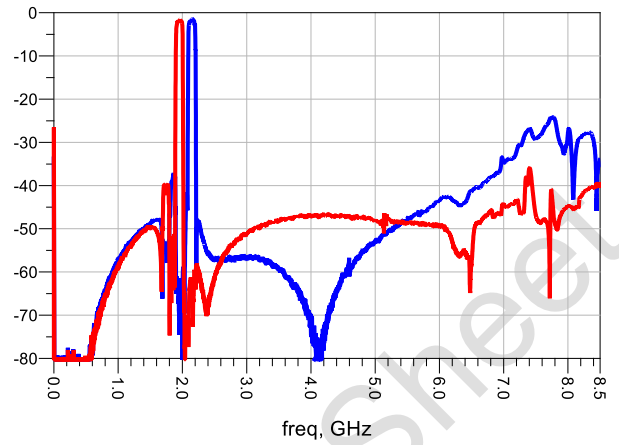

Figure8. Bnad1 TX/RX Wideband

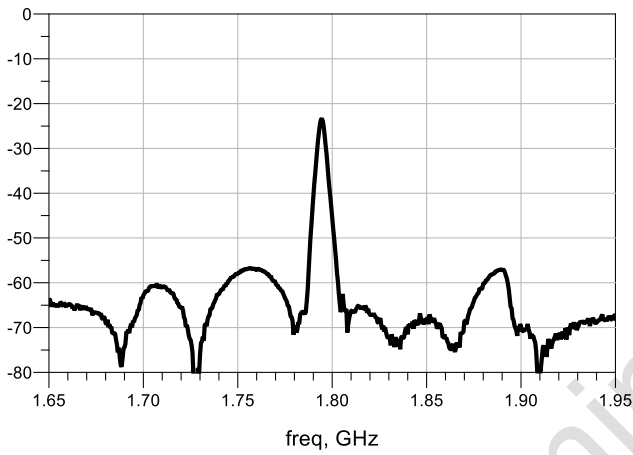

Figure9. Band3 TX - RX Isolation

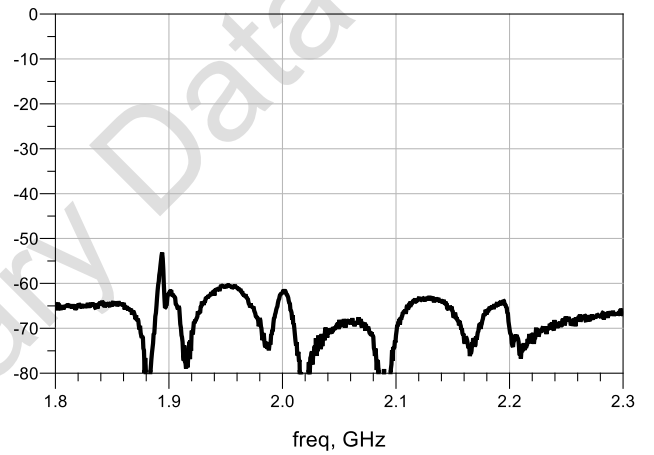

Figure10. Band1 TX - RX Isolation

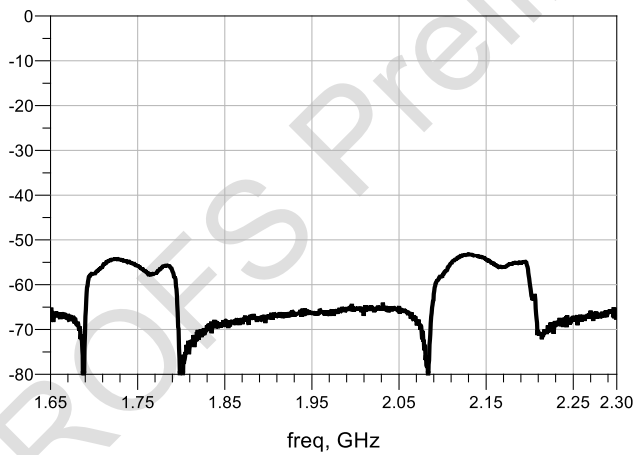

Figure11. Band3 TX - Band1 RX Cross Isolation

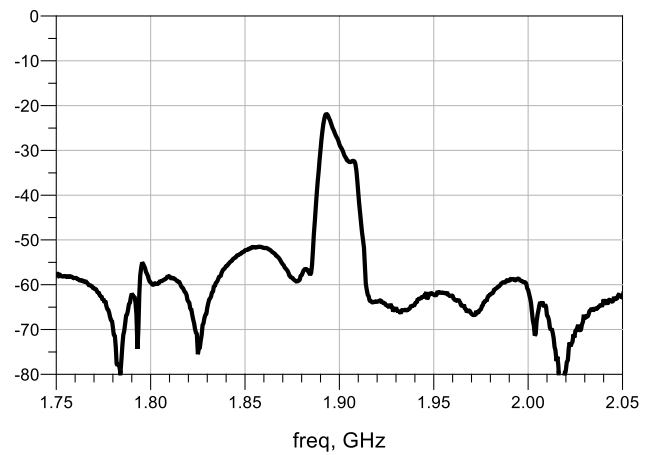

Figure12. Band1 TX - Band3 RX Cross Isolation

Typical Performance at Tc=25°C

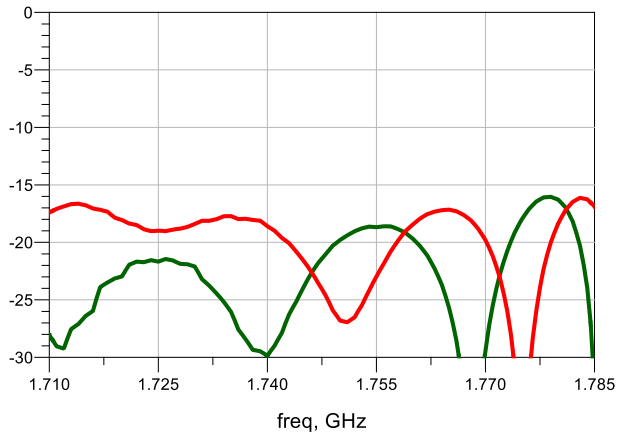

Figure13. Band3 TX (Tx/Ant Port) Return Loss

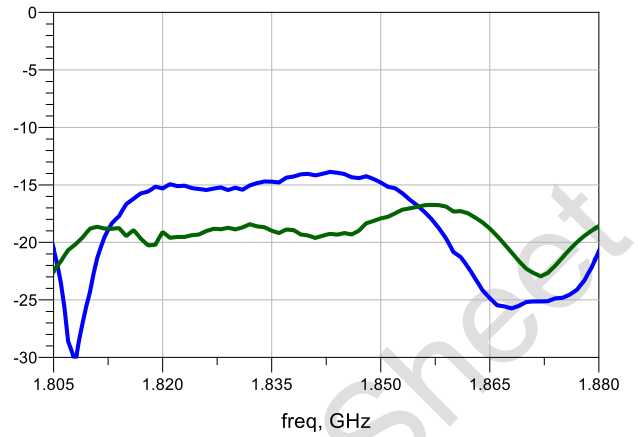

Figure14. Band3 RX (RX/Ant Port) Return Loss

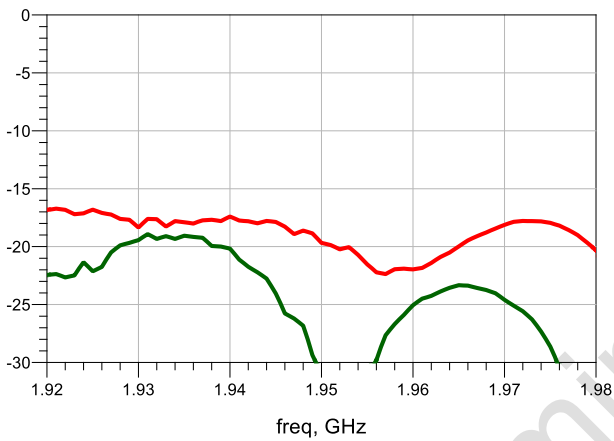

Figure15. Band1 TX (Tx/Ant Port) Return Loss

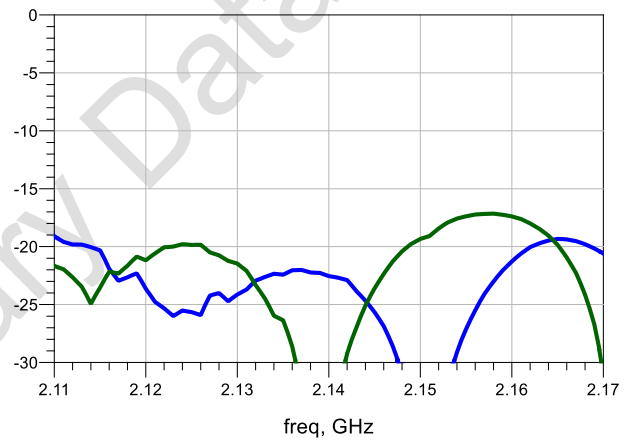
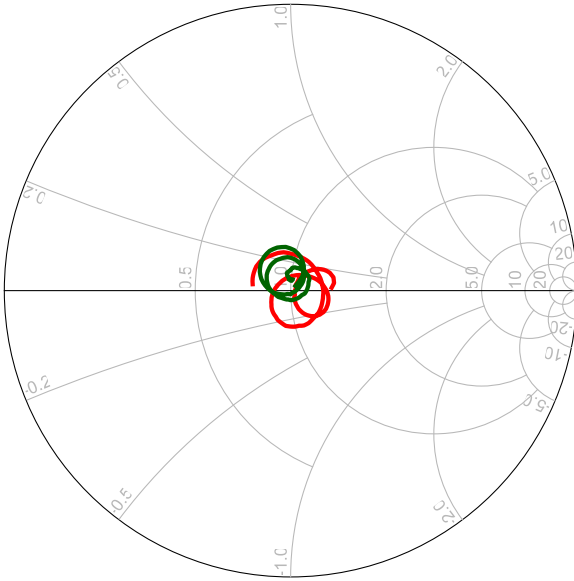

Figure16. Band1 RX (RX/Ant Port) Return Loss

Typical Performance at Tc=25°C



freq (1.710GHz to 1.785GHz)

Figure17. Band3 TX (Tx/Ant Port) Smith Chart

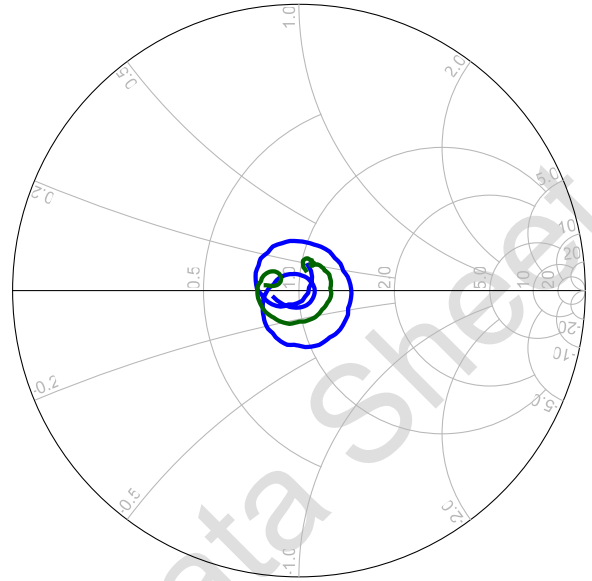

freq (1.805GHz to 1.880GHz)

Figure18. Band3 TX (Rx/Ant Port) Smith Chart

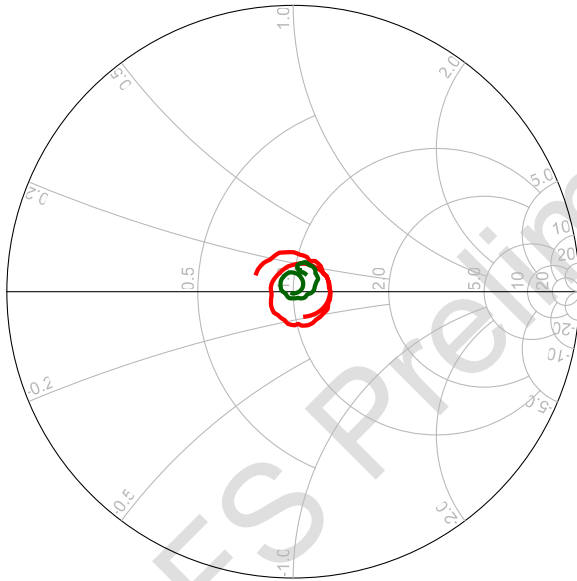

freq (1.920GHz to 1.980GHz)

Figure19. Band1 TX (Tx/Ant Port) Smith Chart

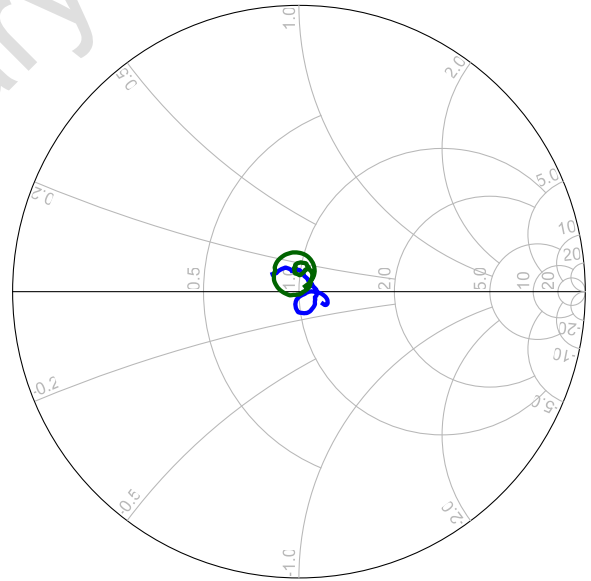

freq (2.110GHz to 2.170GHz)

Figure20. Band1 RX (RX/Ant Port) Smith Chart

Package Outline

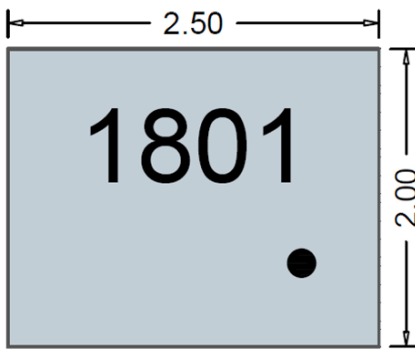

Top View

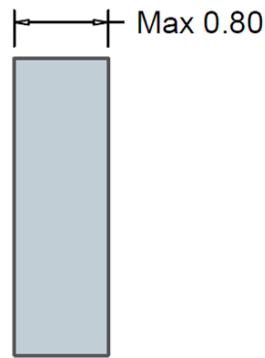

Front View

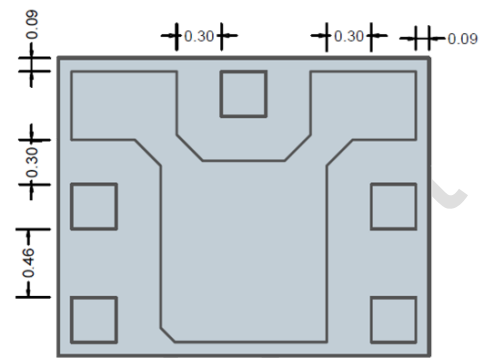

Bottom View

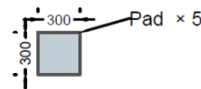
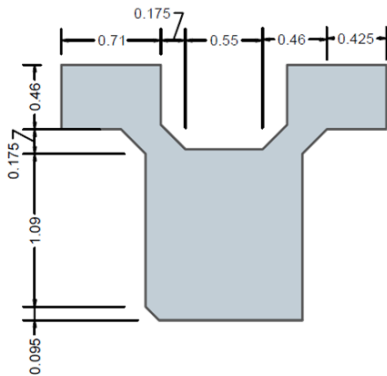

Package dimension tolerance

1. Outline tolerance: ± 0.05
2. Distance between pad tolerance: ± 0.03
3. Pad outline tolerance: ± 0.01

Note:

1. Dimension: mm
2. Dimensions nominal unless otherwise noted
3. Contact area are gold plated
4. Pad(6) is single size, others are same size
5. 1801 is product code

No.	Function
1	Band1 Tx
2	Band3 Tx
3	Ant
4	Band1 Rx
5	Band3 Rx
6	Ground

Order Information

P/N	Qty/Reel	Container
RSFM1801A	3000	7 inch Reel

Packing

1. Tape Dimension

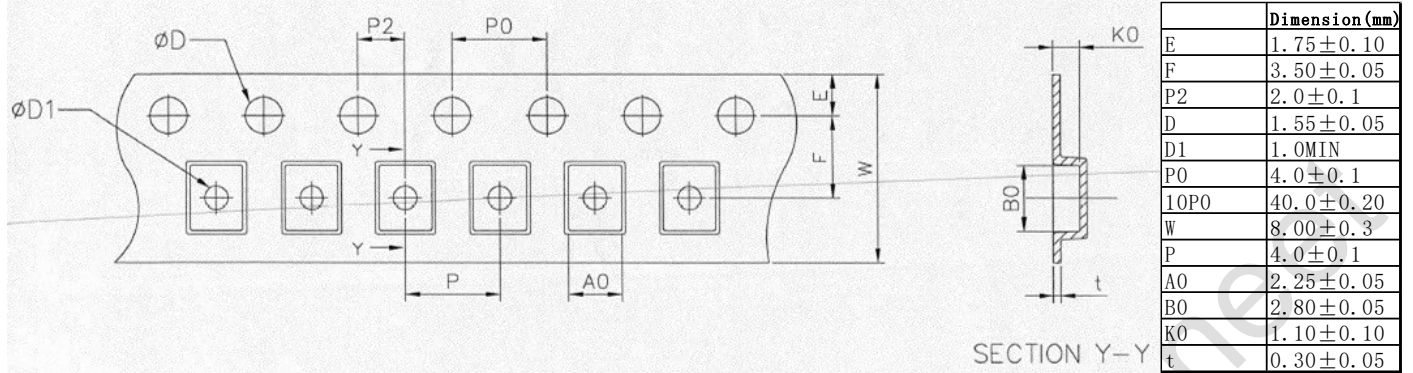

2. Reel Dimension

3000Pcs/Reel

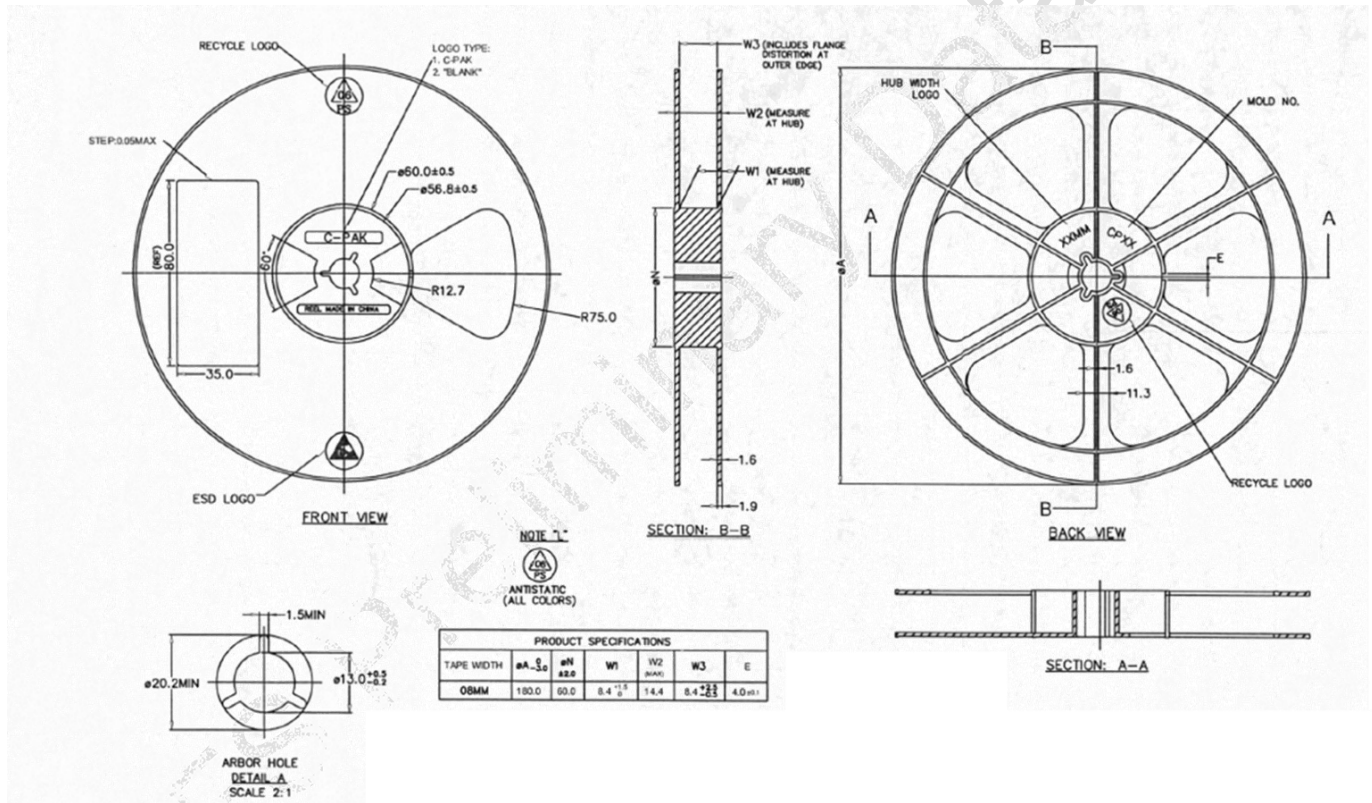

Recommended Reflow Profile

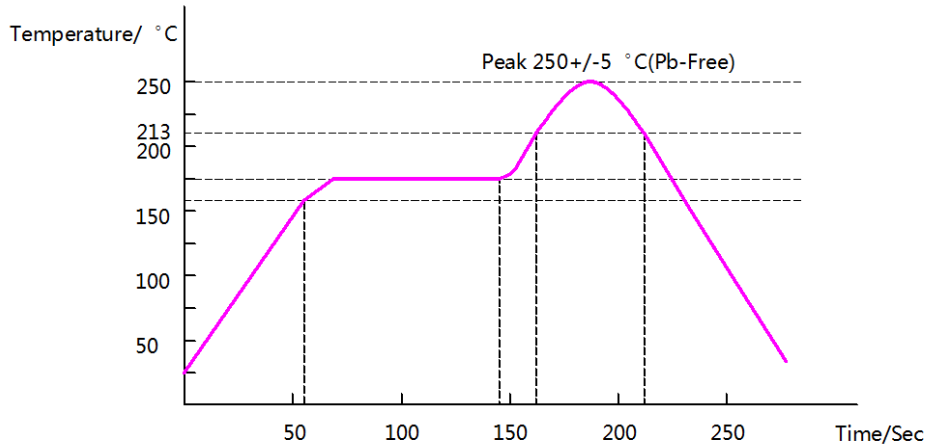

For more information, please contact: sales@rofsmicro.com

Notes:

The specification may be changed or the product had been discontinued, please check with our sales or product engineer before order.